

Quick Installation Guide TBR922/TBR923

Ver.A (P/N: 60177A0651X00)

Accessories

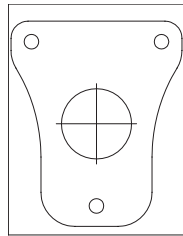

Placement sticker



Quick guide

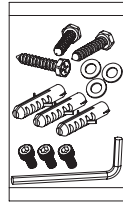

Mounting accessory kit

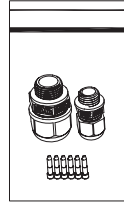

Waterproof connector

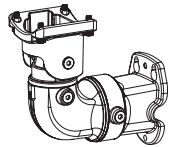

3-axis cable concealed wall mount bracket



Dehumidifier packet



Wall mount base

DI/DO & Function Description

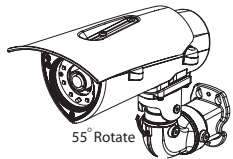

55° Rotate

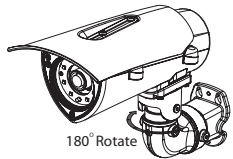

180° Rotate

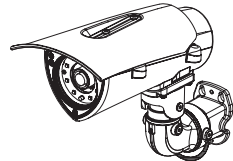

360° Rotate

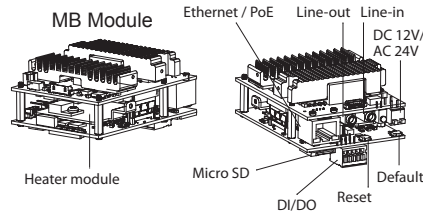
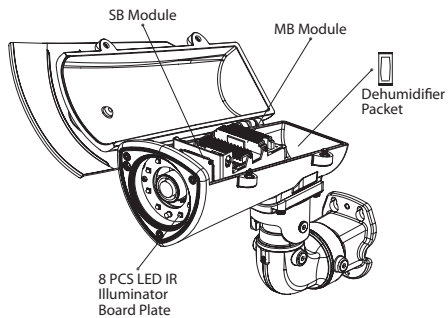

DI/DO Pin Definition & Waterproof Connector Description

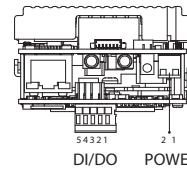

DI/DO

1	ALM_IN (+)
2	ALM_IN (-)
3	ALM_out_NC
4	ALM_out_COM
5	ALM_out_NO

POWER

1	AC24V/DC12V (+)
2	AC24V/DC12V (-)

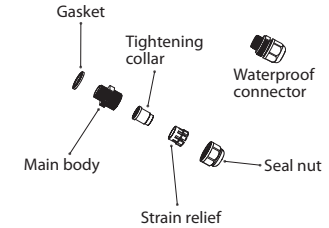

Cable Wiring Description

Cable Installation Steps:

1. Run the cable inside the wall mount bracket and out through the cable opening at the front.
2. Wire the network cables to the waterproof connector on the right, and wire the line-in, line-out, DC 12V/AV 24V, DI/DO and other cables to the waterproof connector on the left. Tighten the waterproof connector after all the cables are secured in place.
3. Secure the camera onto the wall mount bracket using the four screws provided. Unscrew the 2 screws on the camera's top cover at the side in preparation for the next step.
4. Open the camera's top cover to access the wired cables. Install the RJ45 connector to the Ethernet cable and plug it into the corresponding port on the MB module.
5. Close the camera's top cover and secure it with the supplied hardware tool to complete.

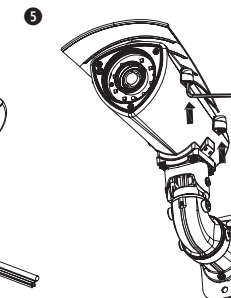
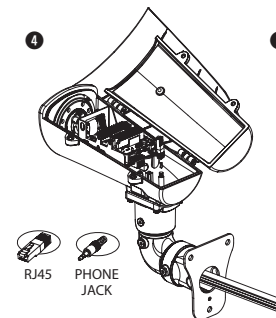
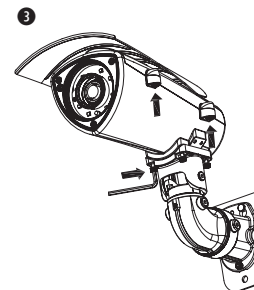
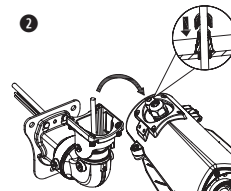
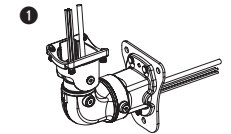

Quick Installation Guide TBR922/TBR923

Ver.A (P/N: 60177A0651X00)

Cable Outlet Description

1. The camera features two waterproof connectors, the right one in the diagram is for PoE connection, while the left one is for line-in, line-out, DC 12V/AC 24V and DI/DO connections.
2. The left one features four wire holes. Please cover unused holes with sealing plugs to prevent water from entering.
3. Applicable cable diameter:
 - * \varnothing 1.8~2.5mm (Left)
 - * \varnothing 4.7~6.9mm (Right)

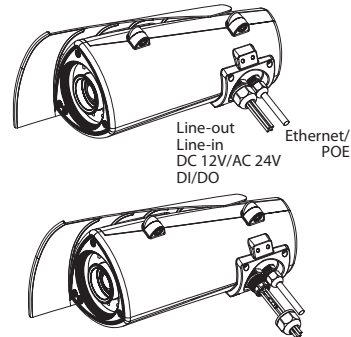

Hardware Installation

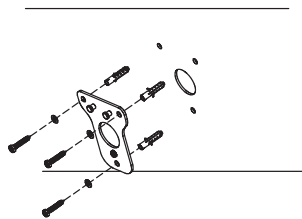
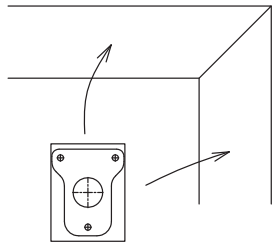

1. Position the placement sticker at the desired installation location and use a driller to drill the holes on the sticker.
2. Insert three screw anchors into the holes then place the wall mount base on top of them with the mounting holes aligned.

3. Wire the required cables through the cable opening on the front of the wall mount bracket. Then, attach and secure the wall mount bracket to the wall mount plate with two M5 screws. Next, install the waterproof connectors onto the cables on the front of the wall mount bracket.

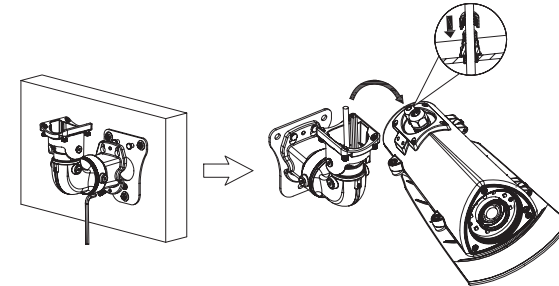

4. Secure the camera to the wall mount bracket with the four screws and hex wrench. Open the camera's cover and connect the cables to their corresponding ports on the MB module. Then, glue the dehumidifier packet onto the metal bracket using the adhesive sticker on its back, as depicted in the diagram below. Quickly close the camera's cover and ensure the clip is locked in position to prevent the dehumidifier packet from losing its effectiveness.

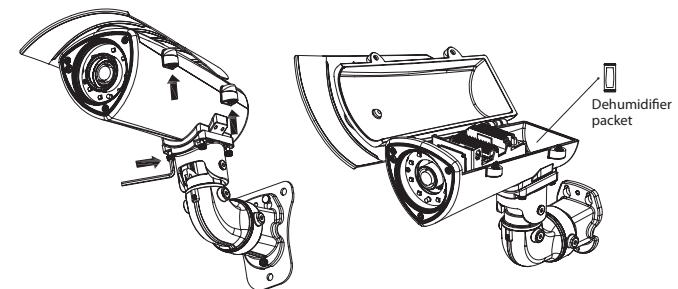

5. Secure the top cover to finish the installation.

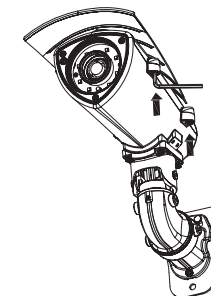

Quick Installation Guide TBR922/TBR923

Ver.A (P/N: 60177A0651X00)

3-axis Angle Adjustment

1. The vertical tilt angle of the camera can be adjusted up or down within an angle of 55°. Loosen the left and right screws depicted below to adjust the vertical tilt angle and then tighten the screws after finishing the adjustment.

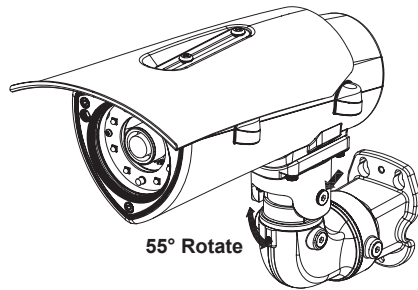

2. The horizontal tilt angle of the camera can be adjusted left or right within an angle of 180°. Loosen the left and right screws depicted below to adjust the horizontal tilt angle and then tighten the screws after finishing the adjustment.

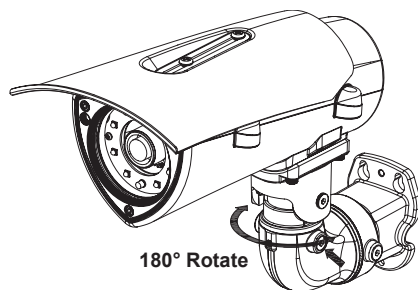

3. The rotatable axis can be rotated in 360°. Loosen the left and right screws depicted below to adjust the 360-degree position and then tighten the screws after finishing the adjustment.

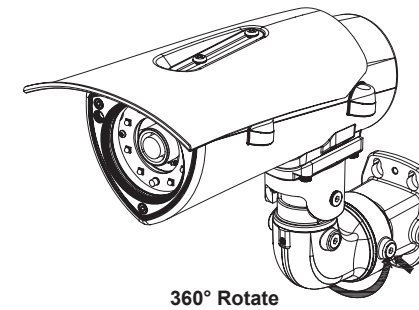

Accessing the Web GUI Login through Web Browser (Internet Explorer)

1. Locate and open the Internet Explorer (IE) shortcut on the desktop.
2. In the address bar, type 192.168.0.250 (default IP address of the camera) and then press the Enter button.
3. You will be prompted with a pop-up window asking for login information, type in "Admin" (default login name) and "1234" (default password).

Quick Installation Guide TBR922/TBR923

Ver.A (P/N: 60177A0651X00)

Recommended Installation Guideline

The ANPR/LPR camera series are specially designed to capture high-quality images of vehicle license plates. They are able to overcome varied light conditions and capture license plates clearly without overexposure. They are ideal for monitoring parking lots and public areas (city surveillance), and for controlling vehicle access in vehicle identification and license plate recognition applications.

The following recommended installation guideline would be helpful to attain an optimized image result.

Angle

The maximum mounting angle of an ANPR/LPR camera to a vehicle is 30 degrees for both horizontal and vertical views.

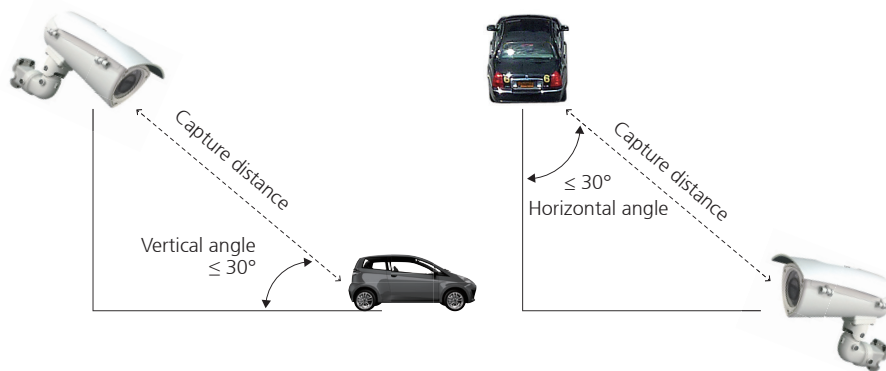

Figure 1. Recommended Vertical and Horizontal Mounting Angles

Note:

If the actual installation distance is over 20m (66ft), please consider to add an external IR illuminator as an auxiliary tool to enhance IR light.

License Plate Capture Distance and Vehicle Speed

Each model in the ANPR/LPR camera series has a recommended license plate capture distance and the relative vehicle speed as shown in the table below.

Model No.	License Plate Capture Distance	Vehicle Speed
TBR922	5m-15m (16ft ~ 49ft)	200km/h
TBR923	15m-50m (49ft ~ 164ft)	200km/h.

Note: The Quick Guide is subject to change without notice
2018-05-31 released